

Description

The panel mounting Power Controllers TCP3 are suitable for providing control of electric heating loads from an analogue signal. Applications include electric heating coils, heating cables and electric furnaces. The units utilise solid-state switching with "zero crossing technology" to provide accurate switching control. All items are provided with an alarm output for over temperature protection and LED Indication of Output ON. The TCP3 are designed to mount on the control panel backplate.

Features

- Selectable Control Input
- 27Kw, 36Kw and 57Kw Models
- Over Temperature Protection
- 24Vac/dc or self-powered options
- LED Indication
- Panel Mounted



Technical Specification

Input:	Selectable 0...10V, 0...5V, 2...10V, 4...20mA	
Power Supply:	24Vac/dc +/-10% (self-powered option)	
Alarm Output:	24V alarm output drops to 0V on alarm for connecting to external relay	
Max Heater Duty:	27Kw, 36Kw or 57Kw dependent on model	
Rated Load:	Load/Ph	Dissipated Heat
	27Kw 37A	84W
	36Kw 50A	100W
	57Kw 80A	160W
Rated Supply:	380...440Vac, 50/60Hz	
LED Indication:	ON when output is on.	
Terminals:	Control – Rising cage terminals Power – DIN rail terminals	
Ambient Temp:	Maximum 45°C without de-rating	
Dimensions:	27/36Kw - 257 x 102 x 142 mm 57Kw - 257 x 200 x 158 mm	
Country of Origin:	United Kingdom	

Order Codes

TCP3-27	Three Phase Panel Mount Thyristor Controller 27Kw
TCP3-36	Three Phase Panel Mount Thyristor Controller 36Kw
TCP3-57	Three Phase Panel Mount Thyristor Controller 57Kw
TCP3-x-SP	Self-powered Option Factory fitted

Installation and Configuration

The TCP3-x is suitable mounting on a control panel backplate and fixing holes are provided for this purpose. The fixing centres for this are:

27/36Kw Units: 237 x 60 mm

57Kw Units: 237 x 140 mm

The units must be installed with the heatsink cooling fins orientated vertically. There should be a minimum of 100mm vertically between units.

Electrical Installation

Installation must be carried out by a suitably trained electrician, and in accordance with the relevant statutory regulations.

Load Supply and Back-up Protection

High speed fuses or miniature circuit breakers should be utilised to provide back-up protection to the switching devices. It is recommended that a load disconnect switch and a contactor are installed in the load supply.

Control Supply

The unit is supplied as standard with the requirement for a 24Vac/dc auxiliary power supply. There is the option of having a transformer fitted to the unit so that the unit is self-powered without the need for an auxiliary supply. If this option is used then it is essential to connect your neutral to the neutral terminal. See wiring for details. The control supply common is linked to the 0-10V Input Signal common. Screened cable should be used for connections to BMS Controllers, where possible the cable screen should be connected to a functional earth and at one end only to avoid earth loops.

Cycle Time & Signal Rescaling

The unit is supplied with the cycle time set to minimum. An on-board potentiometer is provided to facilitate adjustment of the cycle time in the range of 5 to 60 seconds.

Maximum Heating Load

The power rating of the units are given as a guide. The maximum current (which is dependant on the actual supply voltage and heating load) as shown in the above table must not be exceeded.

E.C. Products Limited - Head Office

EC House, Amberley Way, Hounslow
Middlesex, TW4 6BH, United Kingdom

Tel: +44 (0)20 8569 4100 Fax: +44 (0)20 8569 4111

Operation

The TCP3-x has been designed to control electric heating loads in proportion to the incoming, selectable analogue signal. Control of the load is facilitated by the use of solid-state semiconductor devices and feature zero crossing point switching of the AC load which virtually eliminates RFI problems.

Caution

In normal operation the heatsink surface can exceed 90°C. Dangerous voltages exist on the PCB and particular care should be taken. The TCP3-x must be installed in accordance with the relevant statutory regulations and installation must be carried out by an experienced and fully qualified engineer.

Ventilation

The TCP3-x is suitable for use up to a maximum ambient temperature of 45°C which should not be exceeded. If necessary, enclosures or control panels should be ventilated with a cooling fan, particularly if the unit is being used to run at full power to provide forced cool air movement over the heatsink.

Over Temperature Monitoring

The TCP3-x is provide with an electronic thermal cut-out fitted to the heatsink to protect against over temperature. The unit will switch off the load if the heatsink temperature exceeds 95°C and will automatically reconnect the load once the heatsink temperature has dropped below 85°C. Upon switching, the alarm output from the control PCB will change from 24V to 0V.

The heatsink temperature will not reach 95°C under normal operating conditions. However, this might occur if the ambient temperature exceeds 45°C.

Jumper Settings

Voltage Inputs



I/V Jumper

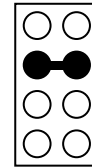

0...10Vdc

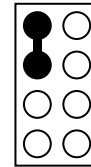

0...5Vdc

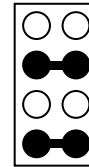

2...10Vdc

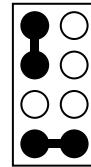

1...5Vdc

Current Inputs



I/V Jumper

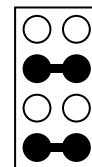

4...20mA

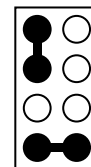

2...10mA

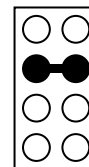

0...20mA

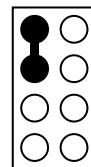

0...10mA

Wiring

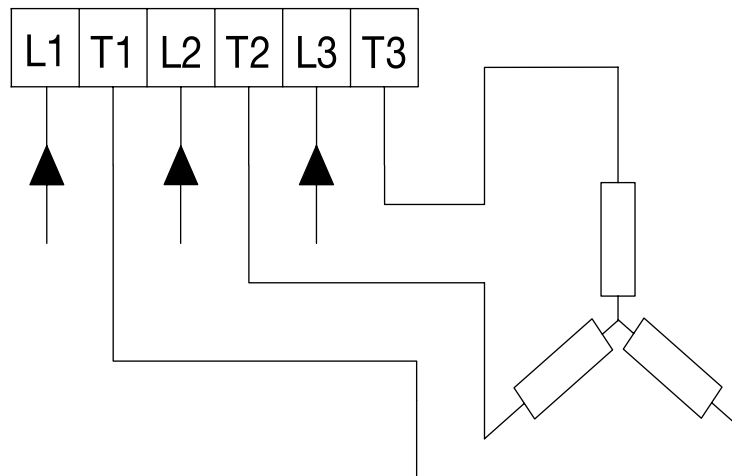
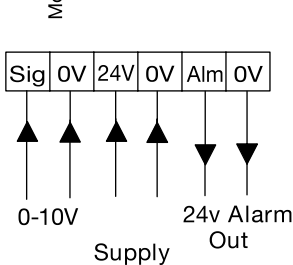
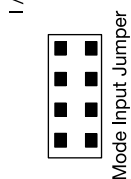
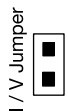
E.C. Products Limited - Head Office

 EC House, Amberley Way, Hounslow
 Middlesex, TW4 6BH, United Kingdom

Tel: +44 (0)20 8569 4100 Fax: +44 (0)20 8569 4111