

Description

XB2 series pushbuttons are used in the control of electrical circuits. A choice of panel mounting bezel and colours is available as well as different combinations of contact block. Illuminated versions can also be supplied.

Features

- Choice of colours
- Choice of bezel



Technical Specification

Rated Insulation Voltage: 660V
Operating Temperature: -5...+40°C
Operating Humidity: 45...85% RH
Contact Rating: 10(6)A @ 400V
Electrical Life: 50 x 10⁵ operations
Protection: IP40

Circuits

Order Codes

XB2-BA11	Normally open pushbutton white - metal bezel
XB2-BA21	Normally open pushbutton black - metal bezel
XB2-BA31	Normally open pushbutton green - metal bezel
XB2-BA42	Normally closed pushbutton red - metal bezel
XB2-BA51	Normally open pushbutton yellow - metal bezel
XB2-BA61	Normally open pushbutton blue - metal bezel
XB2-EA11	Normally open pushbutton white - plastic bezel
XB2-EA21	Normally open pushbutton black - plastic bezel
XB2-EA31	Normally open pushbutton green - plastic bezel
XB2-EA42	Normally closed pushbutton red - plastic bezel
XB2-EA51	Normally open pushbutton yellow - plastic bezel
XB2-EA61	Normally open pushbutton blue - plastic bezel
ZB2-BE101	Normally Open Contact Block
ZB2-BE102	Normally Closed Contact Block

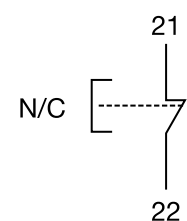
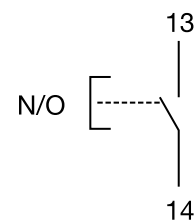

ZB2-BE10

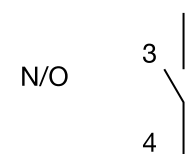

ZB2-BE102

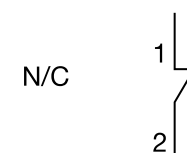

E.C. Products Limited - Head Office

EC House, Amberley Way, Hounslow
Middlesex, TW4 6BH, United Kingdom

Tel: +44 (0)20 8569 4100 Fax: +44 (0)20 8569 4111

Dimensions

XB2-BAx

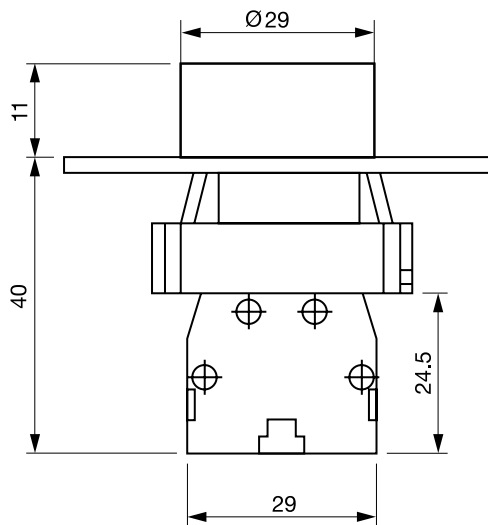

XB2-EAx

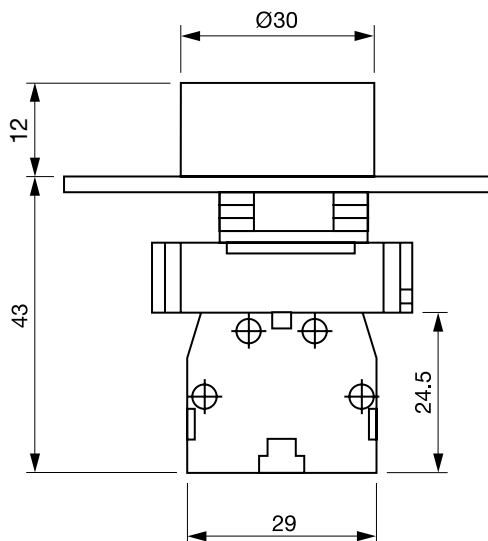

ZB2-BE

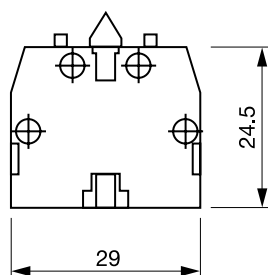

E.C. Products Limited - Head Office

EC House, Amberley Way, Hounslow
Middlesex, TW4 6BH, United Kingdom

Tel: +44 (0)20 8569 4100 Fax: +44 (0)20 8569 4111